

Lemi[®]
ITALIAN WELLNESS EQUIPMENT



CLASSIC



FAVORITE
TREATMENT TABLE MANUFACTURER

All the treatment tables of the CLASSIC line feature the traditional mattress with horseshoe headrest, and are suitable for body massages and facial treatments. All are electrically adjustable (height, back, leg) and allow the relax position.

Tutti i lettini della linea CLASSIC presentano il tradizionale materasso con testa a ferro di cavallo, e risultano idonei a massaggi corpo, trattamenti viso. Tutti sono regolabili elettricamente (altezza schiena gamba) e permettono la posizione relax.



*KIT WENGÈ - KIT WHITE - KIT TAUPE



Chair position / Posizione poltrona



Tilting adjustment / Regolazione basculante

COD. 1436

The Verona is a highly-advanced multifunctional Spa table that combines the strength and elegance of the design with the exceptional comfort of the mattress with horseshoe headrest. Thanks to its fully electric adjustment of height, backrest, legrest and tilting, the Verona treatment table is DUAL USE: it can be used as a chair or as a bed. Available in 3 standard color configurations.

IDEAL FOR: massages, face and body treatments, hair removal, treatments with aesthetic equipment.

Verona è un lettino Spa multifunzionale altamente avanzato che combina la forza e l'eleganza del design con l'eccezionale comfort del materasso dotato di testa a ferro di cavallo. Grazie alla regolazione completamente elettrica dell'altezza, dello schienale, del poggiatesta e della basculante, il lettino Verona è DUAL USE: può quindi essere utilizzato sia come poltrona che come lettino. Disponibile in 3 configurazioni colore standard.

IDEALE PER: massaggi, trattamenti viso e corpo, depilazione, trattamenti con apparecchiature estetiche.

FROM BED
TO CHAIR
DA LETTINO
A POLTRONA

* The images are for illustrative purposes only and may not reflect the actual image of the finishing.

* Le immagini hanno valore puramente illustrativo e possono non rispecchiare l'immagine reale della finitura.

Focus on

- 4 electric adjustments for height, backrest, legrest and tilting allowing for DUAL USE
- Standard handset control with 2 options for MEMORY function
- ZAK mattress with extendable foot section, allowing the table to be used in chair position **NEW**
- AUT function: automatic return from any position to zero position (flat and minimum height)
- END function: "End of treatment" position
- Mattress with horseshoe headrest
- Fire retardant, "Azo" free, antibacterial, antifungal covering
- Multifunctional solution, maximum customer / operator comfort

- 4 movimenti elettrici per regolazione di altezza, schienale, gamba e basculante che lo rendono DUAL USE
- Pulsantiera standard con 2 opzioni di funzione MEMORIE
- Materasso ZAK con piede estraibile, che permette l'utilizzo del lettino in posizione poltrona **NEW**
- Funzione AUT: ritorno automatico da ogni posizione alla posizione zero (piatto e altezza minima)
- Funzione END: posizione "fine del trattamento"
- Materasso con testa a ferro di cavallo
- Rivestimento ignifugo, "Azo" free, antibatterico, antimicotico
- Soluzione multifunzionale, massimo comfort cliente / operatore

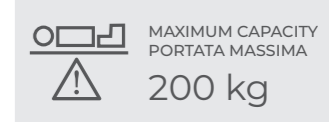
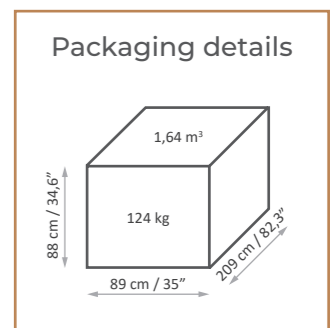
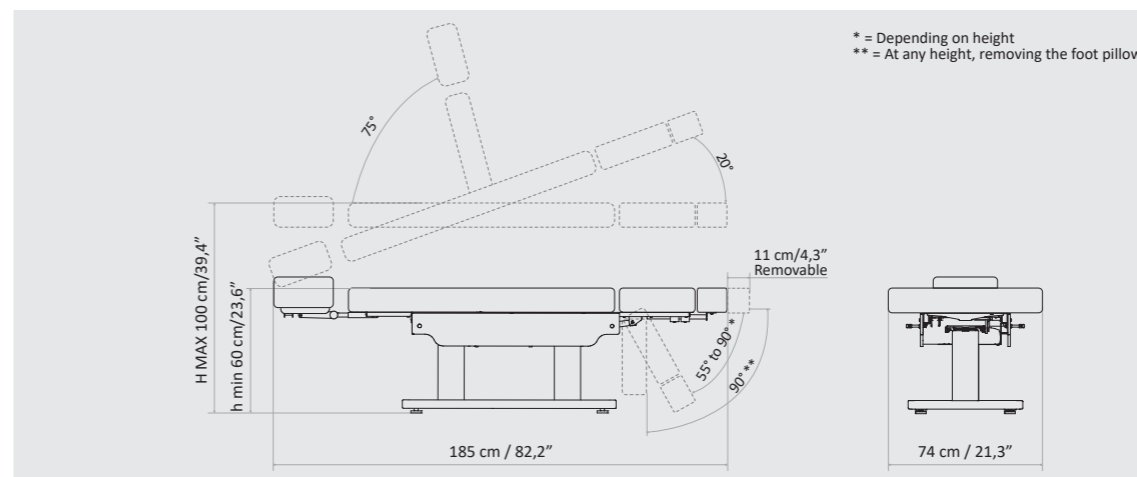

CONFIGURAZIONI DISPONIBILI AVAILABLE CONFIGURATIONS

ACCESSORIES UPON REQUEST ACCESSORI SU RICHIESTA

All tables have a standard setting customizable upon request.

Tutti i lettini hanno una configurazione standard personalizzabile su richiesta.

3 STANDARD CONFIGURATION OPTIONS / 3 OPZIONI DI CONFIGURAZIONE STANDARD

1

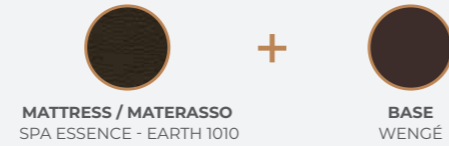

2

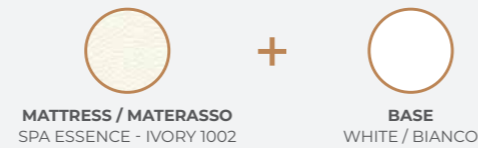

3

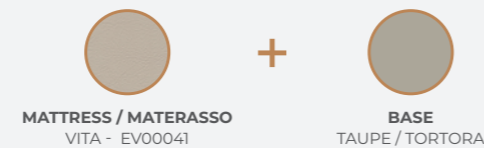

1

WENGÉ

2

WHITE/BIANCO

3

TAUPE/TORTORA

The images are for illustrative purposes only and may not reflect the actual finish of the product, especially when viewed on a screen. For this reason, the SELECTION OF FINISHES MUST ALWAYS BE BASED on the PHYSICAL SAMPLES provided in the official COLOR CHARTS, which offer THE MOST RELIABLE AND ACCURATE REFERENCE.



Arm support
Appoggiabraccia



Mattress protection with polyurethane XL
Coprilettino XL in spugna con poliuretano



Luxury towel
Telo Deluxe



Bluetooth sound system
Sistema Bluetooth



Aromatherapy powered by Camille
Aromaterapia powered by Camille



Perfumed pearls for Kit Aroma Spa (150ml each)
Perle profumate per Kit Aroma Spa (150ml cad.)
- Le Delicat - Mediterranee
- Lux Mint - Polynesie
- Pine



Roll Holder (75 cm)
Portarotolo (75 cm)



Cushion without face hole
Testa senza foro



Pedicure basin with support
Vaschetta Pedicure

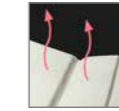

Heating system
Riscaldamento



Wheels with brake (ø 50 mm)
Ruote con freno (ø 50 mm)



Vario Led Flex lamp
Lampada Vario Led Flex



UK cable
Cavo UK



USA cable
Cavo USA



Disposable cover for horseshoe headrest
(250 pcs./pack)
Copritesta monouso testa a ferro di cavallo
(confezione da 250 pz)



Plastic leg protection
Protezione gambe in plastica



Customized mattress with logo
Personalizzazione materasso con logo

Le immagini hanno valore puramente illustrativo e possono non rispecchiare la finitura reale del prodotto, in particolare se visualizzate tramite schermo. Per questo motivo, la SELEZIONE DELLE FINITURE deve BASARSI ESCLUSIVAMENTE sui CAMPIONI FISICI presenti nelle CARTELLE COLORI ufficiali, che rappresentano il RIFERIMENTO PIÙ AFFIDABILE E ACCURATO.

LEMI MATTRESSES STANDARD

Each mattress is HAND CRAFTED, therefore the ACTUAL MEASUREMENTS MAY VARY from those indicated in the catalogue by approximately ± 1 cm (also based on the selected configuration).

MATERASSI LEMI MEMORY

Ogni materasso è realizzato A MANO, pertanto le MISURE REALI POTREBBERO VARIARE rispetto a quelle indicate nel catalogo di circa ± 1 cm (anche in base alla configurazione selezionata).



EVO LINE - STANDARD

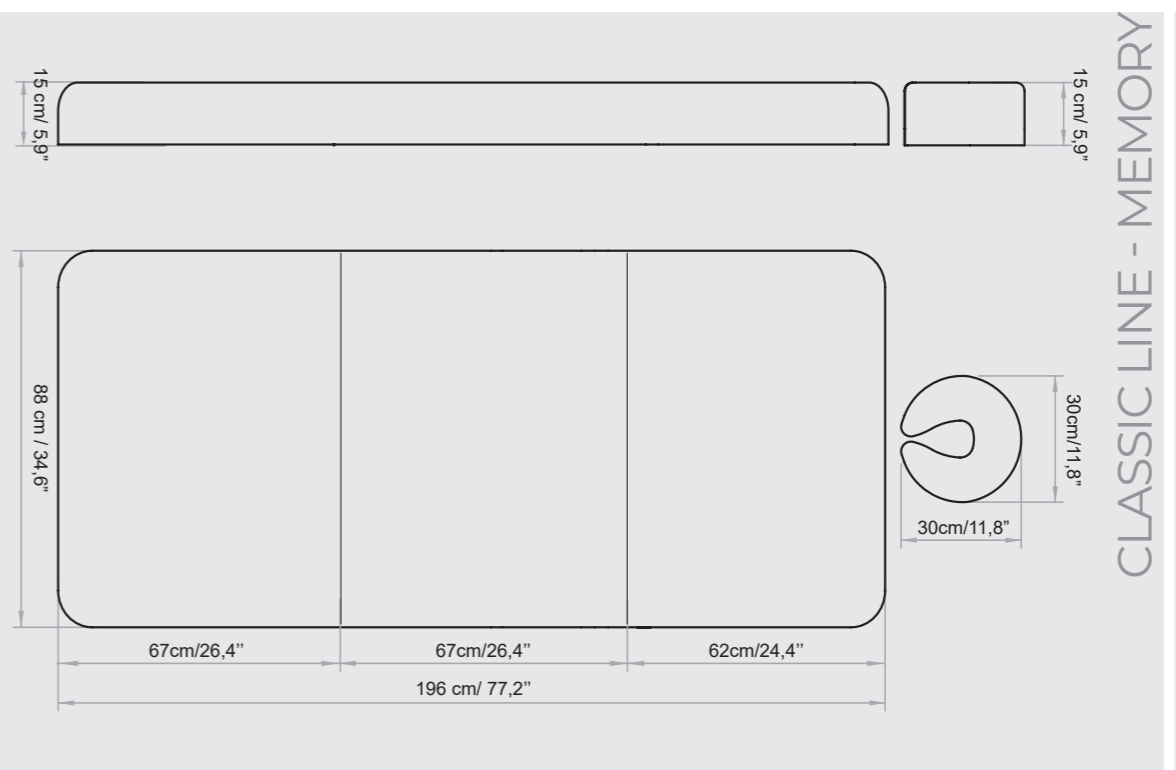
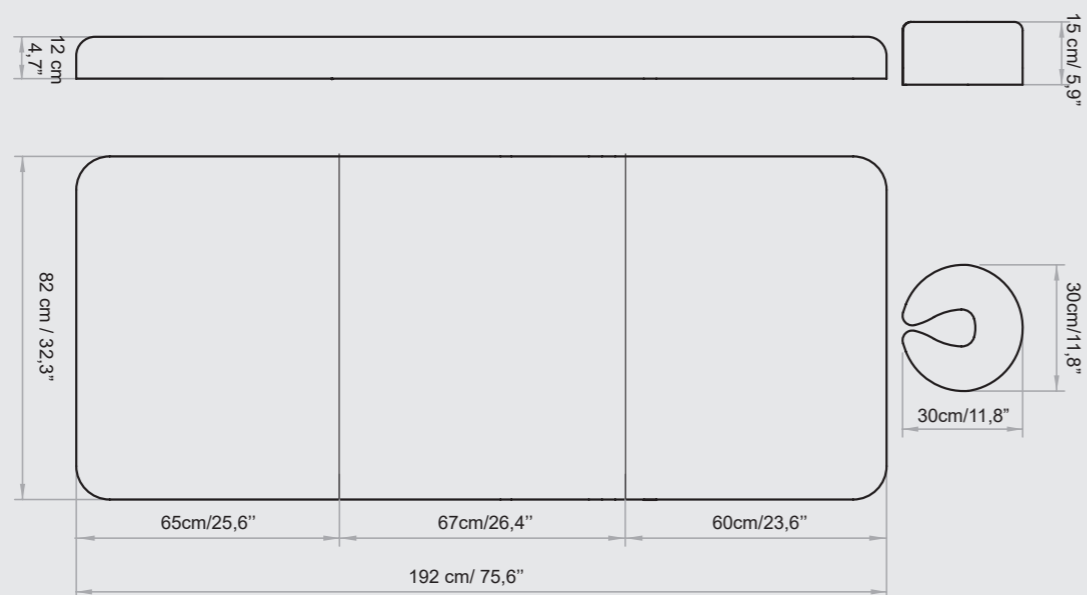

CLASSIC LINE - MEMORY

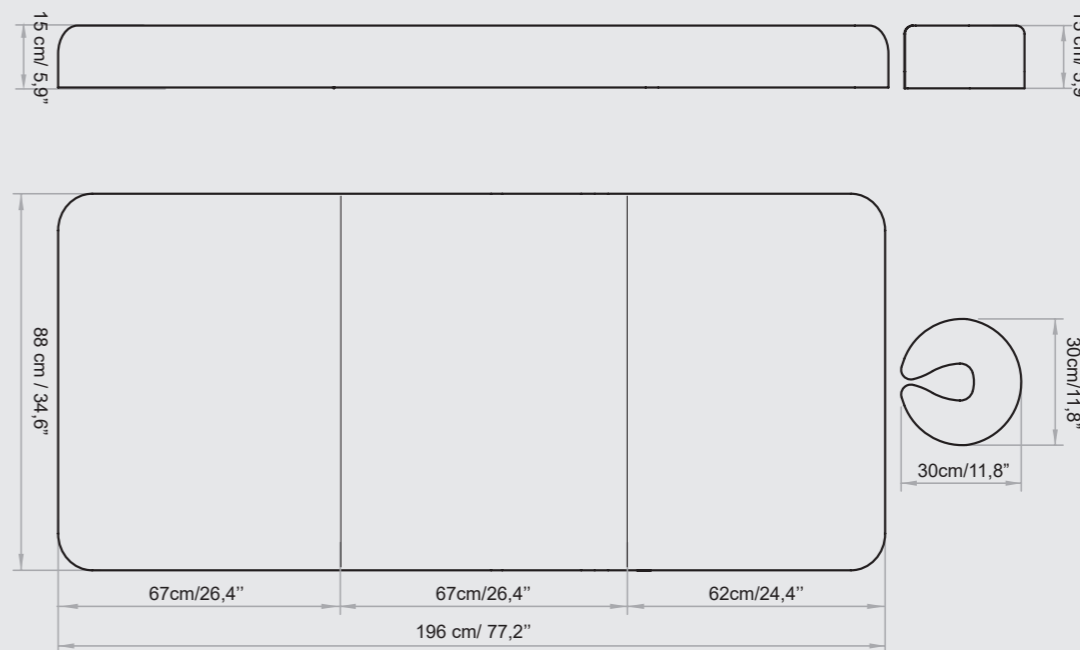

VERONA EVO - STANDARD

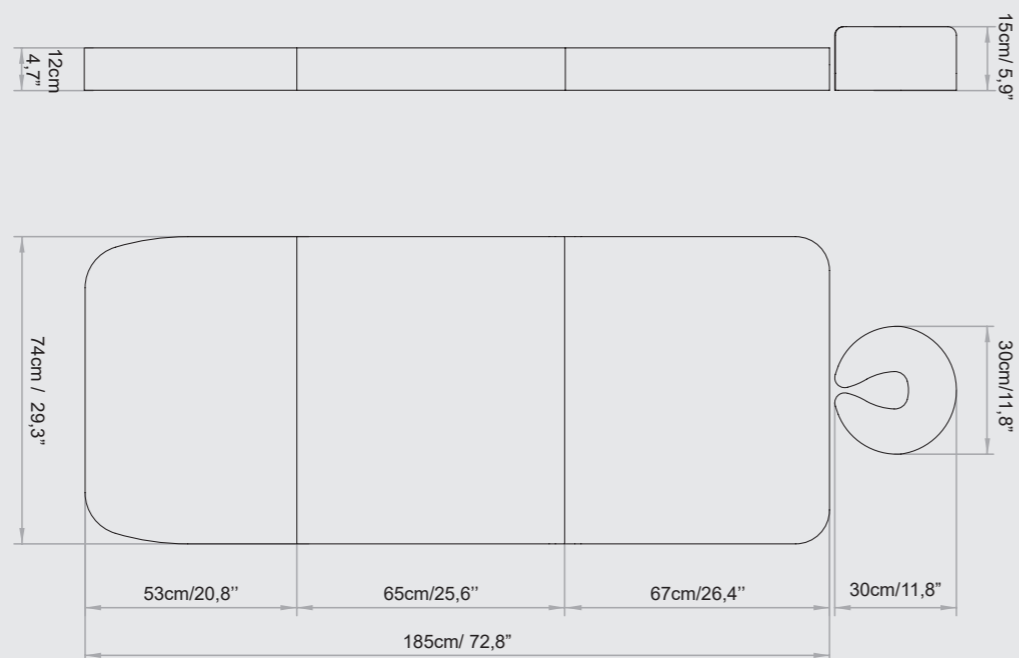

MEMORY FOAM MATTRESS

Super Soft Mattress in Memory Foam Thickness 15 cm

The Memory Foam mattress allows an optimal comfort for the patient even for long-lasting treatments. Furthermore, with the handset control supplied, the guest can independently adjust the chair to find the most comfortable position.

Materasso Super Soft in Memory Foam Spessore 15 cm

Il materasso in Memory Foam permette un comfort ottimale del paziente anche per trattamenti di lunga durata. Inoltre con la pulsantiera in dotazione il cliente può regolare in autonomia la poltrona trovando la posizione più comoda.

TECHNICAL REQUIREMENTS

CARATTERISTICHE TECNICHE

ABSORPTION ASSORBIMENTO	VOLTAGE VOLTAGGIO	POWER POTENZA	FREQUENCY FREQUENZA	WARRANTY	GARANZIA
4 Amax (1,7 A)	100 Vac (240Vac)	250W	50/60 Hz	<i>Mattress heating: 1 year</i> <i>Electric parts and controls: 3 years</i> <i>Undeformable foam: 5 years</i> <i>Actuators: 5 years</i> <i>Structure: Lifetime</i>	Riscaldamento materasso: 1 anno Parti elettriche e comandi: 3 anni Gomma indeformabile: 5 anni Attuatori: 5 anni Struttura: a vita

REGULATIONS

All Equipment is **CE** marked

Electrical equipment and beds

Directive 2006/42/CE (Machinery Directive) and national regulations
 Directive 2014/30/UE (Electromagnetic Compatibility Directive) and national regulations.

Images

The images are for illustrative purposes only and may not reflect the actual image of the product.

NORME

Tutte le attrezzature sono a marchio **CE**

Attrezzature e lettini elettrici

Direttiva 2006/42/CE (Direttiva Macchine) e disposizioni nazionali di attuazione
 Direttiva 2014/30/UE (Direttiva Compatibilità elettromagnetica) e disposizioni nazionali di attuazione.

Immagini

Le immagini hanno valore puramente illustrativo e possono non rispecchiare l'immagine reale del prodotto.

Lemi[®]
 ITALIAN WELLNESS EQUIPMENT

Brusaferrì & C srl

Via Mara Maretti Soldi, 13
 26011 Casalbuttano (CREMONA) ITALY
 Phone +39-0374-363069 Fax +39-0374-363071
 info@lemigroup.it service@lemigroup.it

www.lemispa.com