

Lemi[®]
ITALIAN WELLNESS EQUIPMENT



WATER

The WATER line includes unique up-to-date spa equipment specific for Spa treatments with water, steam bath, hydrotherapy treatments, massages, professional manicure and pedicure.

La linea WATER include delle attrezzature spa che presentano una tecnologia avanzata specifica per trattamenti Spa con acqua, bagni di vapore, trattamenti di idroterapia, massaggi, manicure e pedicure professionale.



* B: Mongolia 2811 | M: Spa Prestige 1422

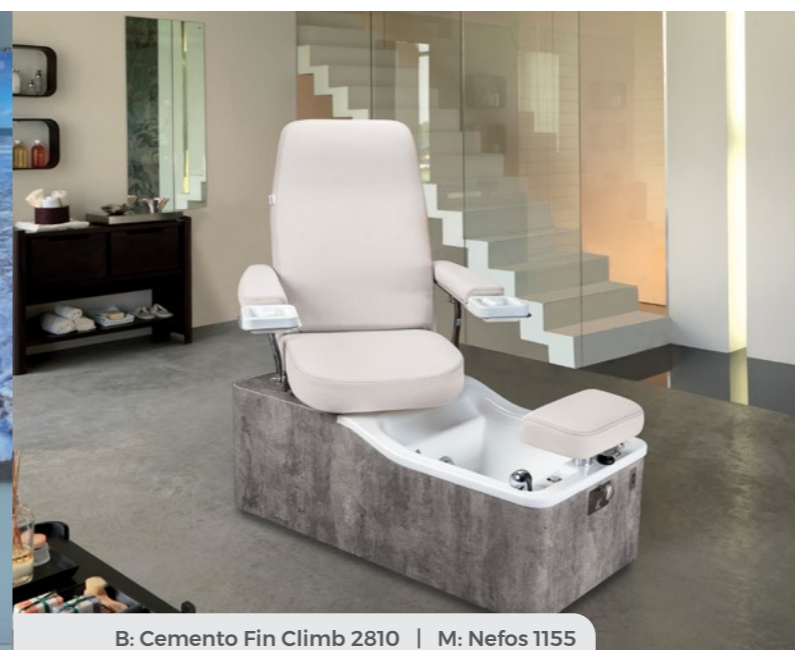

B: Cemento Fin Climb 2810 | M: Nefos 1155

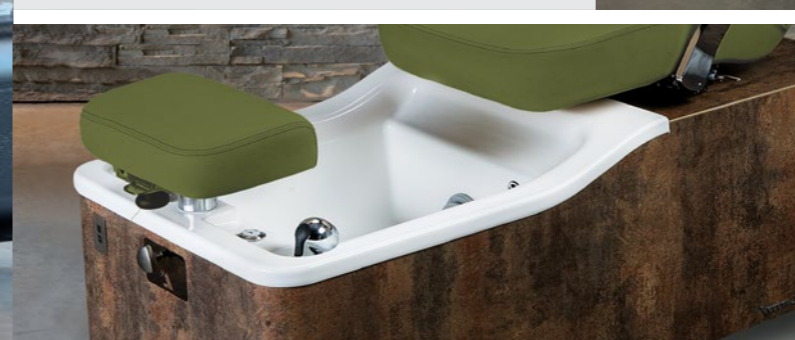

COD. 412

Capri Pedi Spa is the high-level pedicure station featuring modern lines and elegant forms that enrich with charm and design any kind of environment, making the 3 available treatments - pedicure, manicure and facial - a moment of unique relaxation and intense pleasure. Equipped with Pipeless Hydromassage, electrical movement of the seat, 180° chair rotation, backrest with gas-spring. Customizable finishes.

Elba Pedi Spa è la postazione pedicure entry-level caratterizzata da linee moderne e forme eleganti, che arricchiscono di fascino e suggestione ogni tipologia di ambiente, trasformando i 3 trattamenti disponibili - pedicure, manicure e viso - in un unico momento di raffinato relax. Dotata di Hydromassage Pipeless, rotazione della poltrona di 180°, schienale con molla a gas. Finiture personalizzabili.

* The images are for illustrative purposes only and may not reflect the actual image of the finishing.

* Le immagini hanno valore puramente illustrativo e possono non rispecchiare l'immagine reale della finitura.

Focus on

- AUTO-FILL function with automatic fill in of the tub
 - Electric adjustment of the seat
 - Pipeless Hydromassage system guaranteeing maximum hygiene and ease of cleaning
 - 180° manual chair rotation
 - Backrest with gas-spring adjustment
 - Manually adjustable footrest
 - Easy-to-clean manicure bowl
 - Customizable padding and finishes
 - Perfect for pedicure, manicure and facial treatments
- Funzione AUTO-FILL di riempimento automatico della vasca
 - Movimento elettrico della seduta
 - Sistema di idromassaggio "pipeless" che garantisce la massima igiene e semplicità di pulizia
 - Rotazione manuale della poltrona di 180°
 - Schienale con molla a gas regolabile
 - Poggia piedi regolabile manualmente
 - Bacinelle manicure facili da igienizzare
 - Imbottiture e finiture personalizzabili
 - Perfetta per trattamenti piedi, mani e viso

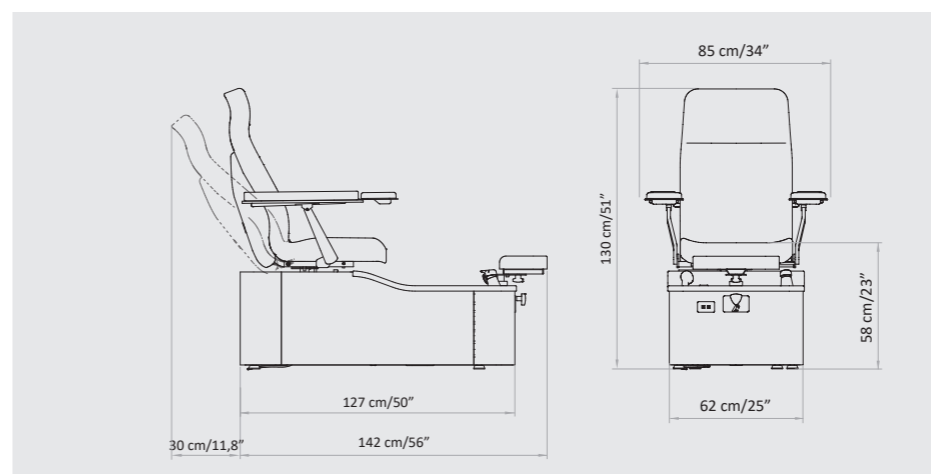

Packaging details

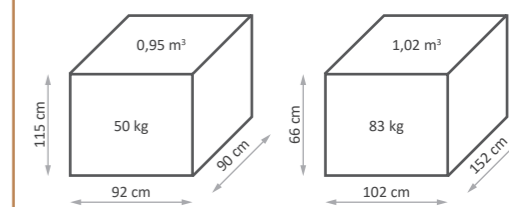
MAXIMUM CAPACITY
PORTATA MASSIMA

200 kg

MATTRESS CUSTOMIZATION

The innovative Spa Prestige and Nefos materials - which are exclusive for LEMI products - and their special finishing touch guarantee easy-cleaning and hygiene. Their extraordinary structural qualities will persist through the years. An incredibly elastic texture enhances the memory foam mattress softness and quality at its best, giving Spa Clients a complete and satisfying wellness experience.

PERSONALIZZAZIONE MATERASSO

Gli innovativi materiali Spa Prestige e Nefos - che sono un'esclusiva dei prodotti LEMI - ed il loro speciale tocco di finitura garantiscono una facile pulizia e igiene. Le loro straordinarie qualità strutturali permangono nel corso degli anni. Una texture incredibilmente elastica migliora al massimo la morbidezza e la qualità del materasso in Memory Foam, dando ai clienti Spa un'esperienza di benessere completa e soddisfacente.

SPA PRESTIGE COLORS

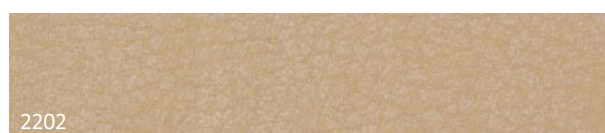
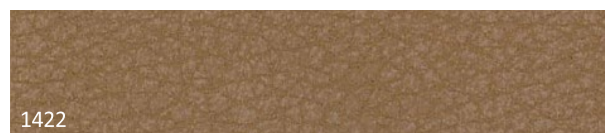
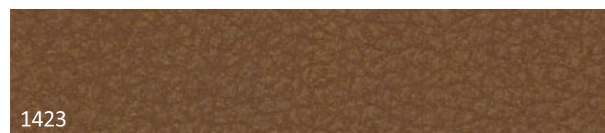
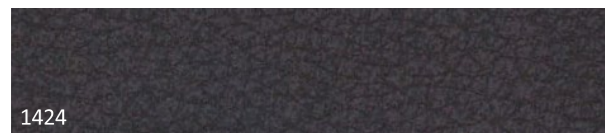

COLORI SPA PRESTIGE

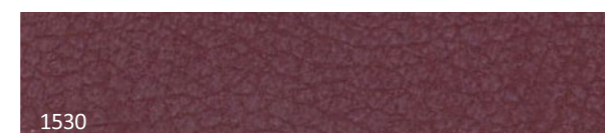
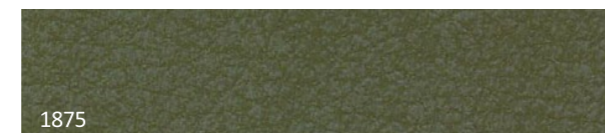
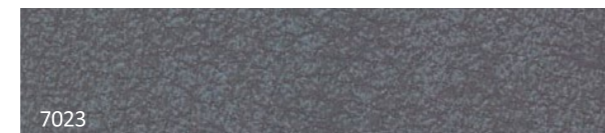
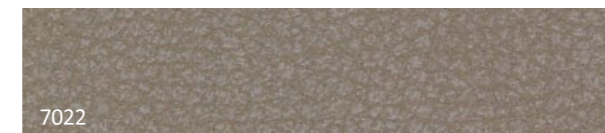

NEFOS COLORS

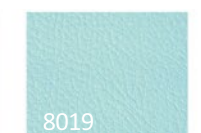
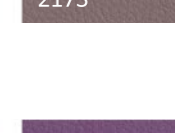
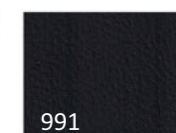
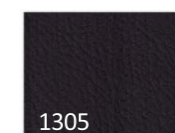
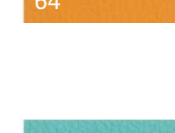
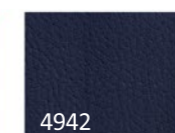
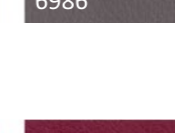
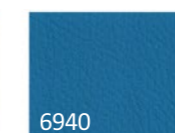
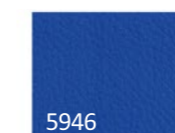
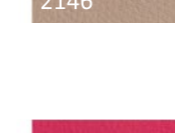

The images are for illustrative purposes only and may not reflect the actual finish of the product, particularly when viewed through a screen. Therefore, the **SELECTION OF THE FINISHES** of the bases and mattress **FABRICS** must take place **AFTER CONSULTING** the **LUXURY BOX PHYSICAL SAMPLES** and the NEFOS and SPA PRESTIGE **COLOR CHART**.

Le immagini hanno valore puramente illustrativo e possono non rispecchiare la finitura reale del prodotto, in particolare se visualizzate attraverso uno schermo. Pertanto la **SELEZIONE DELLE FINITURE** delle **BASI** e dei **RIVESTIMENTI** dei materassi deve avvenire **PREVIA CONSULTAZIONE** della **CAMPIONATURA FISICA** della **LUXURY BOX** e delle **CARTELLE COLORI** NEFOS e SPA PRESTIGE.

BASE CUSTOMIZATION

Today, 70% of the company's wooden equipment and treatment tables are manufactured using FSC certified lumber from unprotected forests. The woods are furnished by suppliers that have committed themselves to sustainable development, guaranteeing full compliance with the best environmental protection practices.

PERSONALIZZAZIONE BASE

Oggi, il 70% delle attrezzature e dei lettini in legno dell'azienda sono realizzati con legname certificato FSC proveniente da foreste non protette. I legni provengono da fornitori che si sono impegnati per lo sviluppo sostenibile, garantendo il pieno rispetto delle migliori pratiche di tutela ambientale.

ACCESSORIES UPON REQUEST ACCESSORI SU RICHIESTA

All Water beds have a standard setting customizable upon request.

Tutti i lettini Water hanno accessori standard personalizzabili su richiesta.

Available finishing for CAPRI PEDI SPA Finiture disponibili per CAPRI PEDI SPA

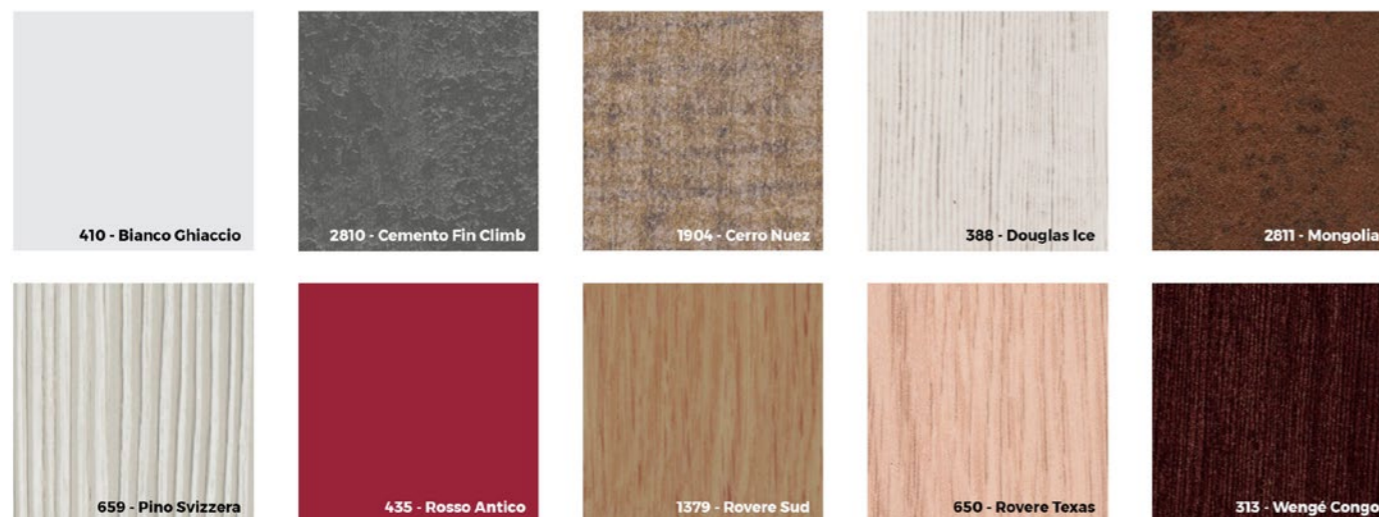

410 - Bianco Ghiaccio	2810 - Cemento Fin Climb	1904 - Cerro Nuez	388 - Douglas Ice	2811 - Mongolia
659 - Pino Svizzera	435 - Rosso Antico	1379 - Rovere Sud	650 - Rovere Texas	313 - Wengé Congo

The images are for illustrative purposes only and may not reflect the actual finish of the product, particularly when viewed through a screen. Therefore, the **SELECTION OF THE FINISHES** of the bases and mattress **FABRICS** must take place **AFTER CONSULTING** the **LUXURY BOX PHYSICAL SAMPLES** and the NEFOS and SPA PRESTIGE **COLOR CHART**.

Le immagini hanno valore puramente illustrativo e possono non rispecchiare la finitura reale del prodotto, in particolare se visualizzate attraverso uno schermo. Pertanto la **SELEZIONE DELLE FINITURE** delle **BASI** e dei **RIVESTIMENTI** dei materassi deve avvenire **PREVIA CONSULTAZIONE** della **CAMPIONATURA FISICA** della **LUXURY BOX** e delle **CARTELLE COLORI** NEFOS e SPA PRESTIGE.

GO KAL

Go Kal cleaner
Detergente Go Kal

SANI GUEST

Sani Guest cleaner
Detergente Sani Guest

KIT DRAIN

Wall mounted drain pump
Kit scarico parete



UK cable
Cavo UK



USA Cable
Cavo USA



Customizable mattress with logo
Personalizzazione materasso con logo

TECHNICAL REQUIREMENTS

CARATTERISTICHE TECNICHE

voltaggio <i>voltage</i>	frequenza <i>frequency</i>	assorbimento <i>absorption</i>	warranty	garanzia
120/220V ac	60/50 Hz	11-5,6 Amp	<i>Electric parts and controls: 2 years Undeformable foam: 5 years Structure: 10 years</i>	<i>Parti elettriche e comandi: 2 anni Gomma indeformabile: 5 anni Struttura: 10 anni</i>

REGULATIONS

All Equipment is **CE** marked

Electrical equipment and beds

Directive 2006/42/CE (Machinery Directive) and national regulations
Directive 2014/30/UE (Electromagnetic Compatibility Directive) and national regulations.

Hydraulic equipment and beds

Directive 2006/42/CE (Machinery Directive) and national regulations

Images

The images are for illustrative purposes only and may not reflect the actual image of the product.

NORME

Tutte le attrezzature sono a marchio **CE**

Attrezzature e lettini elettrici

Direttiva 2006/42/CE (Direttiva Macchine) e disposizioni nazionali di attuazione
Direttiva 2014/30/UE (Direttiva Compatibilità elettromagnetica) e disposizioni nazionali di attuazione.

Attrezzature e lettini idraulici

Direttiva 2006/42/CE (Direttiva Macchine) e disposizioni nazionali di attuazione

Immagini

Le immagini hanno valore puramente illustrativo e possono non rispecchiare l'immagine reale del prodotto.

Lemi[®]
ITALIAN WELLNESS EQUIPMENT

Brusaferrì & C srl

Via Mara Maretti Soldi, 13
26011 Casalbuttano (CREMONA) ITALY
Phone +39-0374-363069 Fax +39-0374-363071
info@lemigroup.it service@lemigroup.it

www.lemigroup.it